

AQUAMONT®

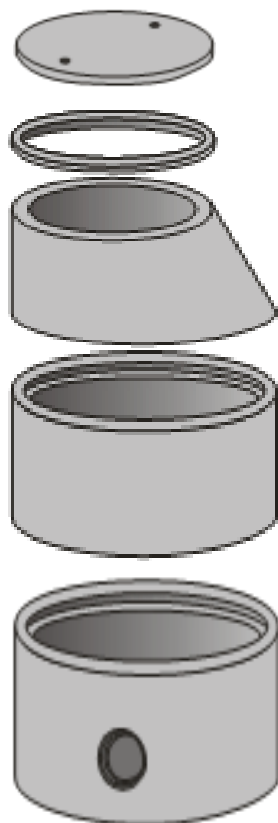

Katalóg

Prvky inžinierských sietí

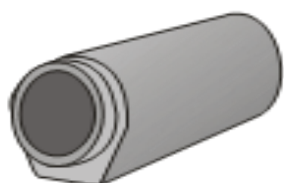
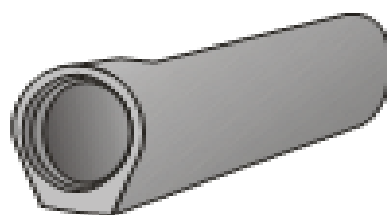
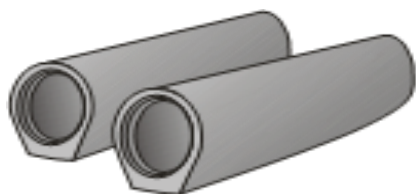



Betónové rúry		vnútorný priemer	hrúbka steny	dĺžka	hmotnosť
		mm	mm	mm	kg / ks*
Betónové rúry hrdlové					
TBH Q 40/250		400	80	2500	770
TBH Q 50/250		500	85	2500	1020
TBH Q 60/250		600	105	2500	1460
TBH Q 80/250		800	150	2500	2675
TBH Q 100/250		1000	160	2500	3825
TBH Q 120/250		1200	165	2500	4625
Betónové rúry priamé					
TBP Q 140/ 250		1400	210	2500	6325
TBP Q 160/ 100		1600	220	1000	3050
TBP Q 160/ 200		1600	220	2000	6100
TBP Q 180/ 200		1800	220	2000	6680
TBP Q 200/ 200		2000	250	2000	8485
TBP Q 220/ 200		2200	220	2000	8000
Podklady pod rúry		pre rúry DN	výška	šírka	hmotnosť
		mm	mm	mm	kg / ks*
TBX Q 30-50/15/17		300-500	170	600	31
TBX Q 60-80/15/17		600	170	800	48
TBX Q 80-80/15/17		800	170	800	48
TBX Q100-100/15/17		1000	170	1000	58
TBX Q120-100/15/17		1200	170	1000	58
TBX Q140-112/20/20		1400	200	1115	80

Betónové rúry železobetónové		vnútorný priemer	hrúbka steny	dĺžka	hmotnosť
		mm	mm	mm	kg / ks*
	Betónové rúry hrdlové				
TZH Q 30/250		300	70	2500	575
TZH Q 40/250		400	80	2500	800
TZH Q 50/250		500	85	2500	1035
TZH Q 60/250		600	95	2500	1480
TZH Q 80/250		800	105	2500	2740
TZH Q100/250		1000	160	2500	3885
TZH Q120/250		1200	165	2500	4740
	Betónové rúry hrdlové, priame				
TZP Q 140/250		1400	210	2500	6325
TZP Q 160/100		1600	220	1000	3100
TZP Q 160/200		1600	220	2000	6200
TZP Q 180/200		1800	220	2000	6850
TZP Q 200/200		2000	250	2000	8660
	Spojovací medzikus				
TZH Q 30/200 PR		300	70	2000	460
TZH Q 40/200 PR		400	80	2000	675
TZH Q 50/200 PR		500	85	2000	840
TZH Q 60/200 PR		600	95	2000	1115
TZH Q 80/200 PR		800	105	2000	1885
TZH Q100/200 PR		1000	160	2000	2900
TZH Q120/200 PR		1200	165	2000	3970
TZH Q140/200 PR		1400	210	2000	4900

Betónové kanalizačné šachty DN 800, hrúbka steny 90 mm		vnútorný priemer	hrúbka steny	výška	hmotnosť
		mm	mm	mm	kg / ks*
	Šachtové skruže				
TBS Q1 80/ 25/9		800	90	250	160
TBS Q1 80/ 50/9		800	90	500	320
TBS Q1 80/100/9		800	90	1000	640
TBS Q1 80/ 25/9 PS	so stupačkami	800	90	250	160
TBS Q1 80/ 50/9 PS	so stupačkami	800	90	500	320
TBS Q1 80/100/9 PS	so stupačkami	800	90	1000	640
	Šachtové kónusy				
TBR Q1 80-63/58/9		800	120	580	508
	Šachtové vyrovnávacie prstence				
TBW Q1 63/4		625	120	40	26
TBW Q1 63/6		625	120	60	39
TBW Q1 63/8		625	120	80	51
TBW Q1 63/10		625	120	100	64
TBW Q1 63/12		625	120	120	80
	Elastomerové tesnenie				
EMT DN 800		800			2

Betónové kanalizačné šachty DN 1000, hrúbka steny 100 mm		vnútorný priemer	hrúbka steny	výška H-celková/ H1 od dna šacht.vložky	hmotnosť
		mm	mm	mm	kg / ks*
Šachtové dna PREFA AQUAMONT					
100/ 50 BK	BEZ KINETY	1000	150	540/380	950
100/ 70 BK	BEZ KINETY	1000	150	740/580	1260
100/100 BK	BEZ KINETY	1000	150	1040/880	1550
100/ 50 K	S KINETOU	1000	150	540/380	1180
100/ 70 K	S KINETOU	1000	150	740/580	1490
100/100 K	S KINETOU	1000	150	1040/880	1920
Šachtové dna PREFA BRNO					
TBZ Q1 100/60	S KINETOU	1000	150	800/600	1600
TBZ Q1 100/80	S KINETOU	1000	150	1000/800	1870
TBZ Q1 100/100	S KINETOU	1000	150	1200/1000	2100
Šachtové vložky zabudované					
HL110	na hladké rúry	110			
HL160	na hladké rúry	160			
HL200	na hladké rúry	200			
HL250	na hladké rúry	250			
HL315	na hladké rúry	315			
HL400	na hladké rúry	400			
HL500	na hladké rúry	500			
KO200	na korugované rúry	200			
KO250	na korugované rúry	250			
KO300	na korugované rúry	300			
KO400	na korugované rúry	400			
KO500	na korugované rúry	500			
KO600	na korugované rúry	600			

Šachtové skruže					
TBS Q1 100/ 25/10		1000	100	250	215
TBS Q1 100/ 50/10		1000	100	500	430
TBS Q1 100/100/10		1000	100	1000	860
TBS Q1 100/ 25/10	so stupačkami	1000	100	250	215
TBS Q1 100/ 50/10	so stupačkami	1000	100	500	430
TBS Q1 100/100/10	so stupačkami	1000	100	1000	860
Šachtový kónus a zákrytová doska					
TBR Q1 100-63/58/10	kónus so stupačkami	1000	100/120	580	505
TZK Q1 100-63/17	zákrytová doska	1000	120	165	430
Šachtové vyrovnávacie prstence					
TBW Q1 63/4		625	120	40	26
TBW Q1 63/6		625	120	60	39
TBW Q1 63/8		625	120	80	51
TBW Q1 63/10		625	120	100	64
TBW Q1 63/12		625	120	120	80
Elastomerové tesnenie					
EMT DN 1000		1000			2

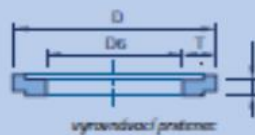

vyrovňovací prstenec

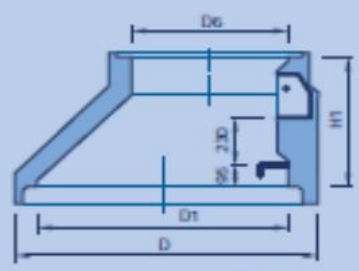
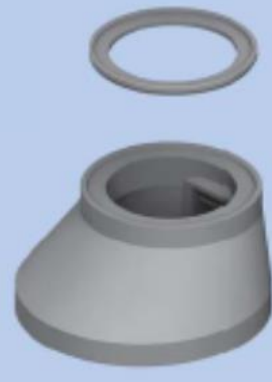

šachťový kónus

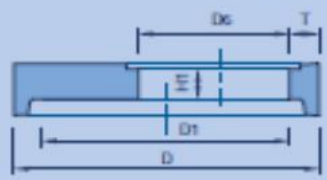
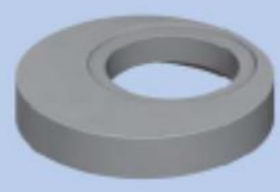

zátková doska

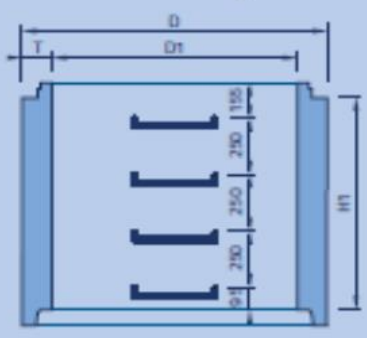
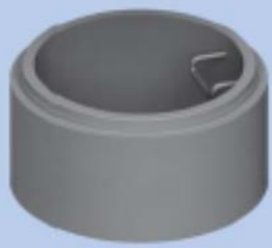

šachťová skruž

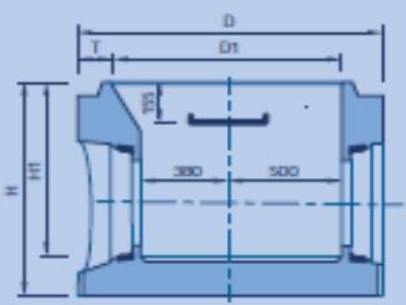
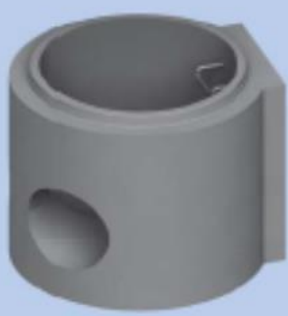

šachťová dno



Uličná vpusť

Typ		vnútorný priemer	výška	hmotnosť
		mm	mm	kg / ks
Dno, dna s otvorom ,sifón				
TBV-Q 450/300/ 2a	dno s kalovou priehlbínou	450	300	80
TBV-Q 450/330/1a	dno s otvorom PVC 160	450	330	96
TBV-Q 450/330/1d	dno s otvorom PVC 200	450	380	108
TBV-Q 450/3z 150	dno- sifon /zápach.uzáverka/ PVC 160	450	570	140
TBV-Q 450/3z 200	dno- sifon /zápach.uzáverka/ PVC 200	450	570	150
Skruže s otvorom				
TBV Q 450/350/3a	skruž s otvorom PVC 160	450	380	75
TBV Q 450/450/3d	skruž s otvorom PVC 200	450	450	90
Skruže stredové, horné				
TBV-Q 450/195/6b	skruž stredová 195	450	195	39
TBV-Q 450/295/6a	skruž stredová 295	450	295	59
TBV-Q 450/570/6d	skruž stredová 570	450	570	109
TBV-Q 450/195/5c	skruž horná 195	450	195	40
TBV-Q 450/195/5b	skruž horná 295	450	295	80
TBV-Q 450/195/5d	skruž horná 570	450	570	110
Prechodová skruž, prstenec				
TBV-Q 11a	Prechodová skruž	450	295	53
TBV-Q 390/60/10a	vyrovnávací prstenec	390	60	25
Mreža, kôš				
liatina/beton	mreža 500x500 „D“ BEGU	500x500	160	104
liatina	Mreža 500x500 „ D“	500x500	150	55
liatina	mreža 450x450 „ D “DONAU	450x450	100	47
B1 pozink.	bahenný kôš	380	270	5,5
B1 z PEHD	bahenný kôš	380	270	2

AQUAMONT®

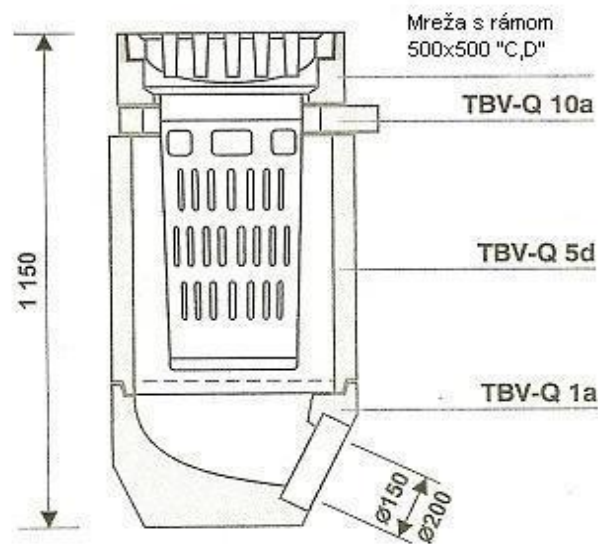
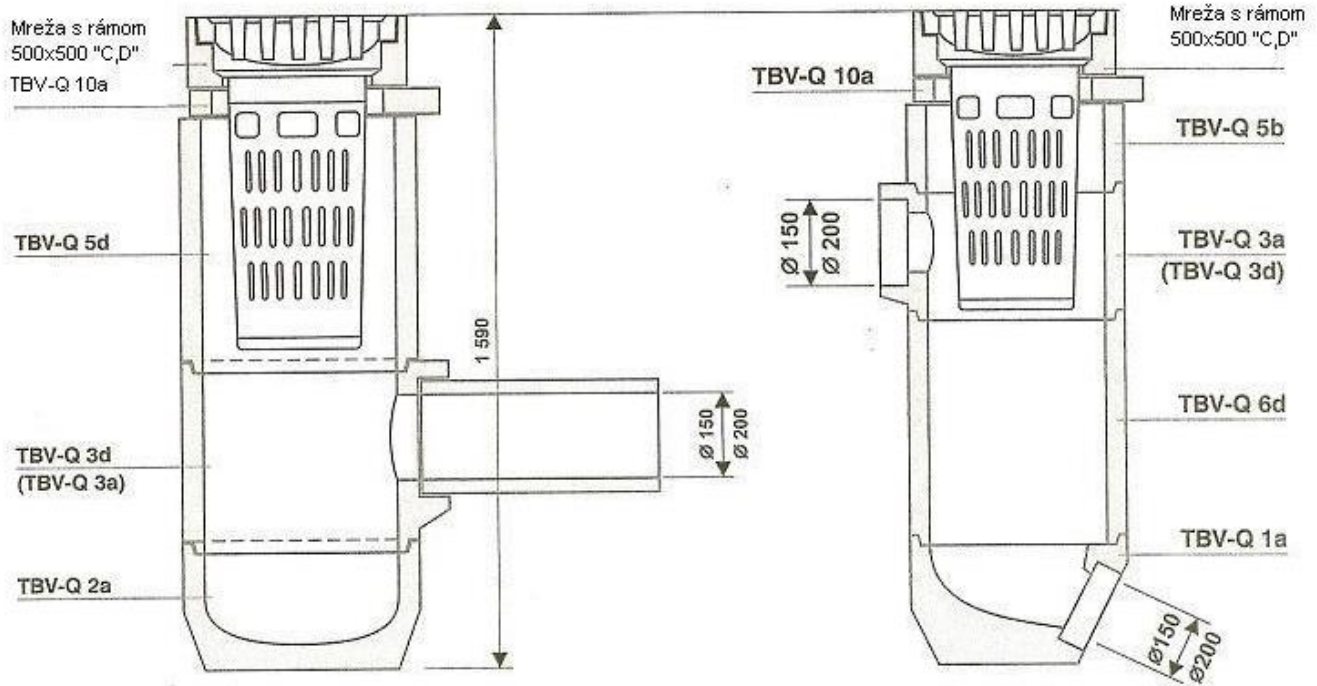

Uličná vpusť- základné rozmery

Mreža 500x500 BEGU

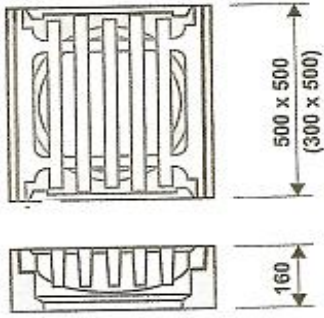

Skruž s otvorom PVC 160 3a

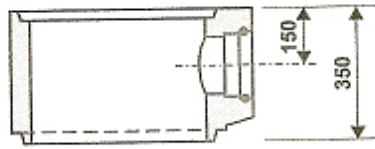

Vyrovnávací prsteneček 10a

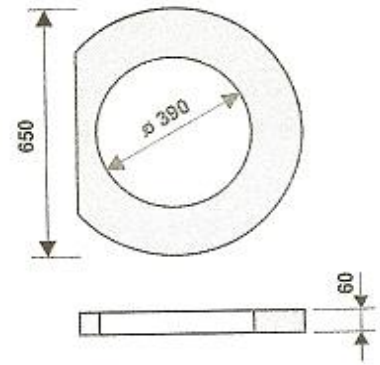

Prechodová skruž 11a

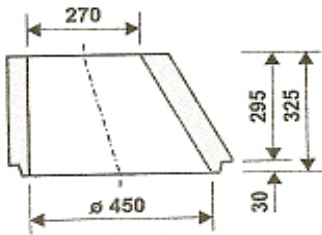

Skruž s otvorom PVC 200 3d

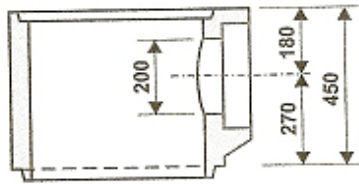

Dno s kalovou priehlbinou 2a

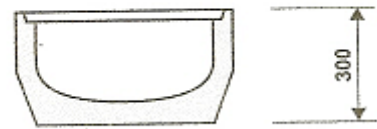

Skruž stredová 6b

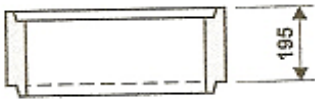

Skruž horná 5c



Dno s výtokom PVC 160 1a

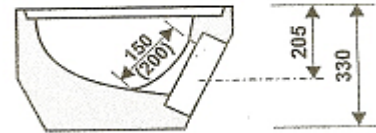

Skruž stredová 6a

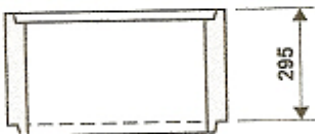

Skruž horná 5b

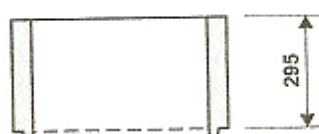

Dno s výtokom PVC 200 1d



Skruž stredová 6d

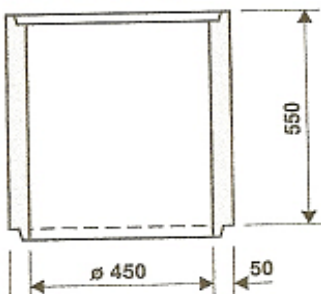

Skruž horná 5d

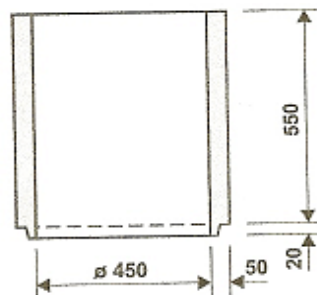

Sifon s výtokom 160,199

